



**Next
Level**
ELEVATORS

ELTEC HLB



The Elevator Specialists

We're passionate about supplying Australians with the most beautiful and functional all-electric elevators. As innovators in this space for almost 10 years' we have exclusive access to the best electric lifts. Our superior, more environmental elevators are known for their reliability and our residential range comes with an impressive 7-year warranty.^

Join us as we continue to redefine the elevator industry within Australia.



P R E M I U M

S E R V I C E



Latest Technology

Our industry leading elevators are made with the latest cutting-edge technology.



Safety

Our elevators meet the strictest safety standards.



Environmental

Our range includes fully electric, eco-friendly, and cost-efficient elevators.



Experience

We have 100 years of combined experience in the elevator industry.



Quick Installation

You can rely on our team for a quick and seamless installation process.



Full Service

From design, through to installation and ongoing maintenance; we provide a complete elevator service.

Eltec HLB

The Eltec HLB is a highly customisable elevator which utilises the latest all-electric traction system. This stunning elevator is one of Australia's most environmentally friendly lifts to operate.



Customise Your Elevator

Create a truly unique elevator experience by choosing from an expansive range of doors, wall panels, flooring, control panels, ceilings and more.

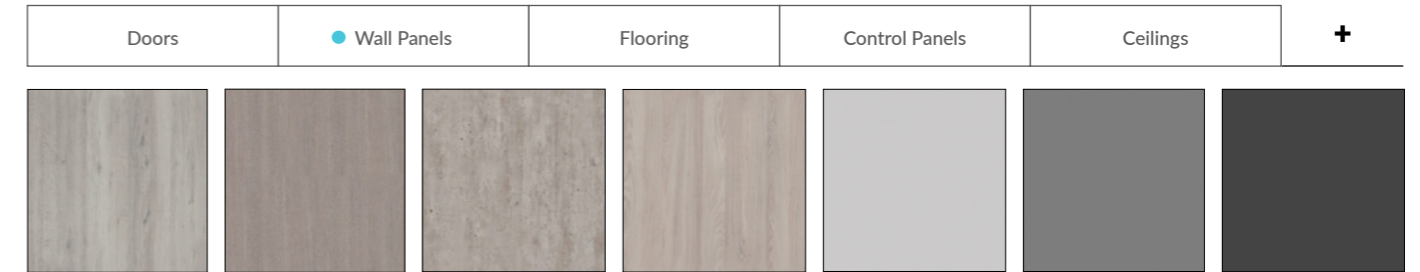

General Specification Information

Regulations	Australian and European
Drive System	VVVF all electric traction system
Country of Origin	Manufactured in Italy
Capacity	200 - 400KG (wheelchair capacity)
Maximum Travel*	20m
Number of Stops*	8
Maximum Speed	0.3m/s
Pit Depth	180mm
Headroom*	2520mm
Motor Room	Motor and controller housed within shaft
Power	Single Phase / 230v 10A



Doors

Premium door options available in either sliding, swing or an exclusive saloon profile. Door finishes come in a range of contemporary metallics and powder coated colours.

Types

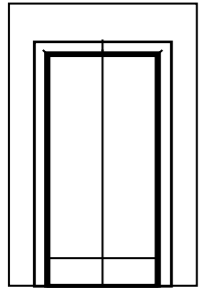

Saloon (M)

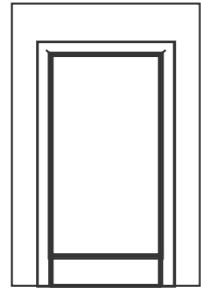

Glass Swing

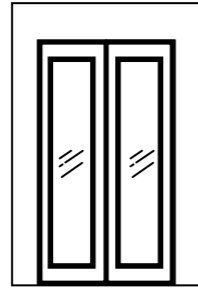

Hybrid Sliding

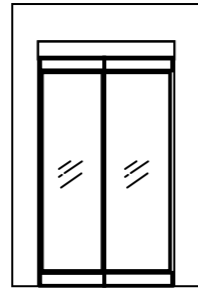

Glass Sliding

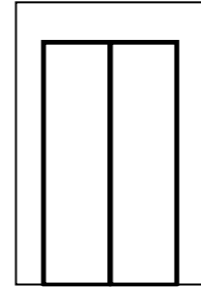

Steel Sliding

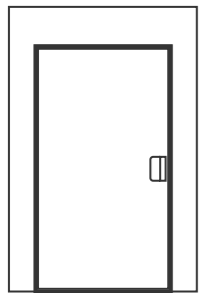

Steel Swing

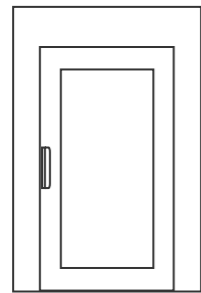

Reverse Swing

Popular Finishes

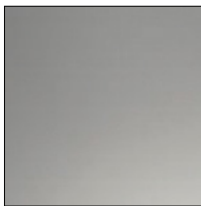

Stainless Steel Linen

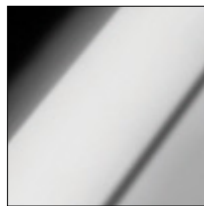

Polished Stainless Steel



Anodised

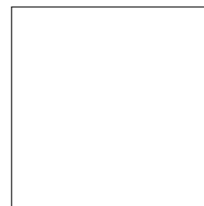

White



Black





Glass Swing Door



Hybrid Sliding Door







Steel Swing Door



Reverse Swing Door

Wall Panels

An array of beautiful cabin finishes ensuring your elevator can be customised to match any interior style. Additional options available upon request.

Solids

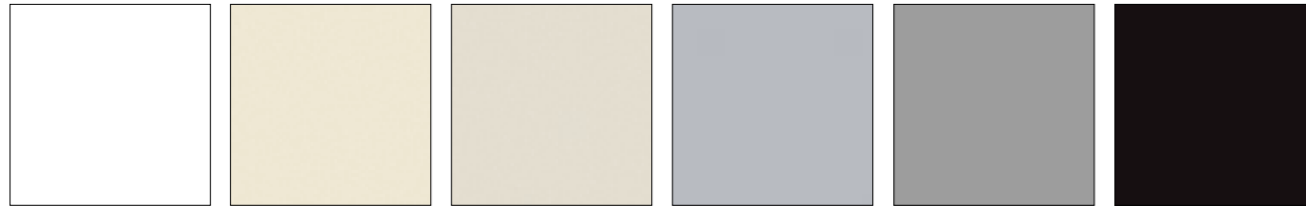

White Porcelain Magnolia Panna Crema Grigio Grigio Perla Black Gloss

Woodgrains



National Oak Rovere Arctic Oak Urban Teak Tobacco

Glass



Transparent Satin Milk Glass Stop Silver Smoked Stop Bronze

Steel



Brushed Linen 2WL

Mirror

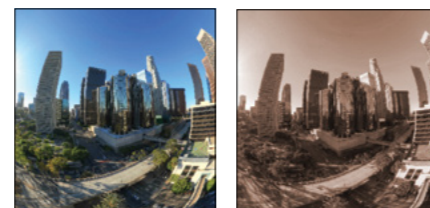

Silver Bronze

Flooring

Select from a range of elegant flooring options which ascend in quality and prestige. Additional options available upon request.

PVC

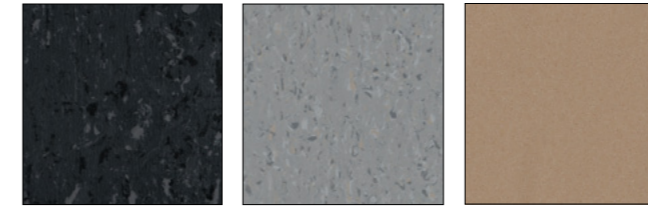

Smart Grey Light Smoke Wheat

Engineered Stone (Standard)

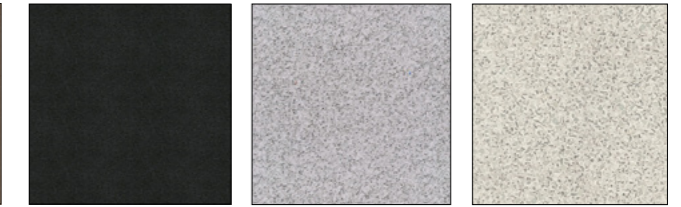

Black Diamond Dove Tail White

Engineered Stone (Advanced)



Graphite Luster Venus Grey Dark Blue

Engineered Stone (Premium)

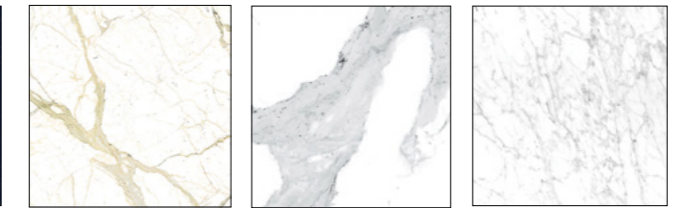

Calacatta Statuario Carrara



Control Panels

Choose from our range of sophisticated control panels which come in a beautiful selection of metallic finishes.

Types

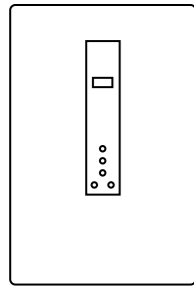

Standard Control Panel

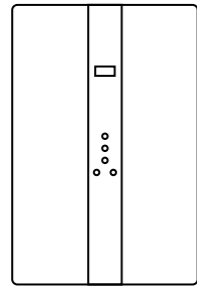

Tower Control Panel

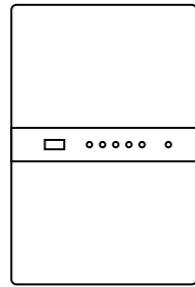

Horizon Control Panel

Popular Finishes



Oxna

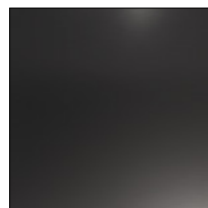

Black (S9E)



Inox San



Black (S9LR)



Inox SR

See the accessories section for screen, button and emergency contact options available with each control panel.



Standard Control Panel



Tower Control Panel



Horizon Control Panel

Ceiling

Select from a range of classic downlight options through to eye-catching statement pieces.

Types

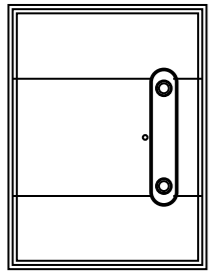

2 Downlights*

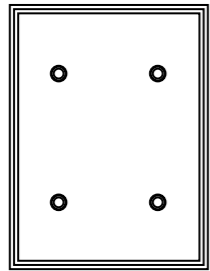

4 Downlights

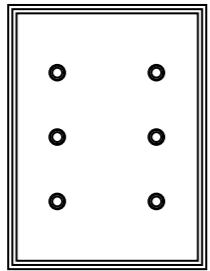

6 Downlights

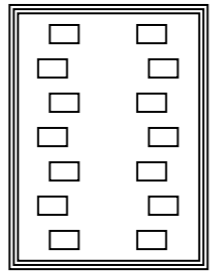

Checked

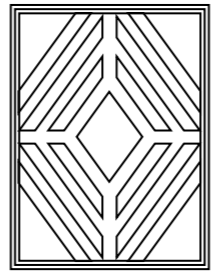

Diamond

Popular Finishes



Inox SB



Mirror Stainless



*Available only in white

Accessories

Apply the finishing touches to your elevator and select from a range of additional accessories.

Displays

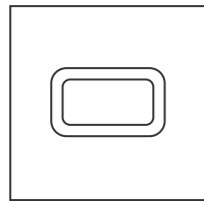

5" LCD (Blue)

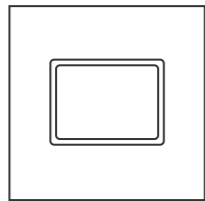

7" TFT (Colour)

Emergency Contact

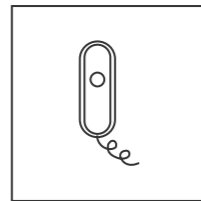

Handset

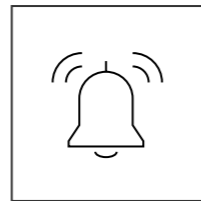

Intercom

Keys

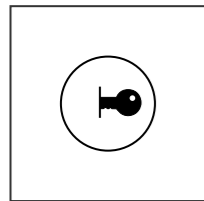

Standard Key

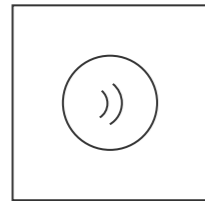

I Button

Buttons

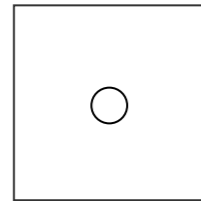

Round Buttons

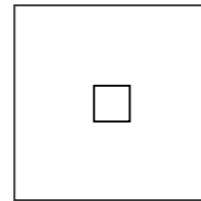

Square Buttons

Mirrors

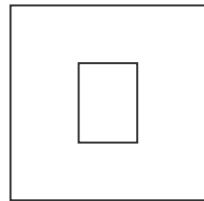

Square 700 x 900 mm

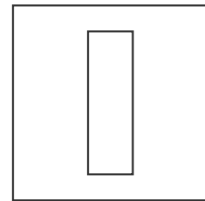

Rectangle 500 x 1600 mm

Handrails

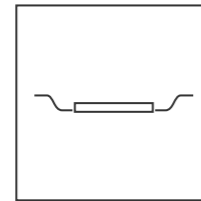

Standard Handrail 25 mm

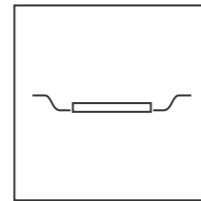

Standard Handrail 32 mm

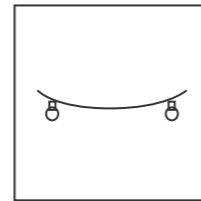

Special Handrail

Visit our showrooms to view additional finishes or download our app to customise your own elevator.



Swing Door

The Eltec HLB with a swing door configuration can be customised to a variety of sizes. Next Level Elevators will work with you and provide specific plans per project.

Single Entry Configurations

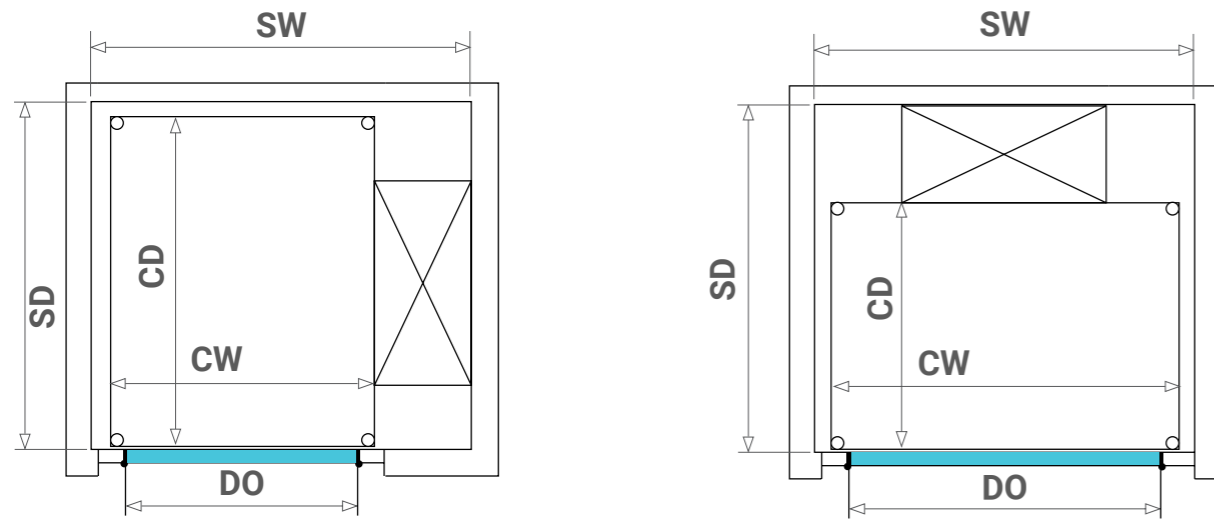

Dual Entry Configurations

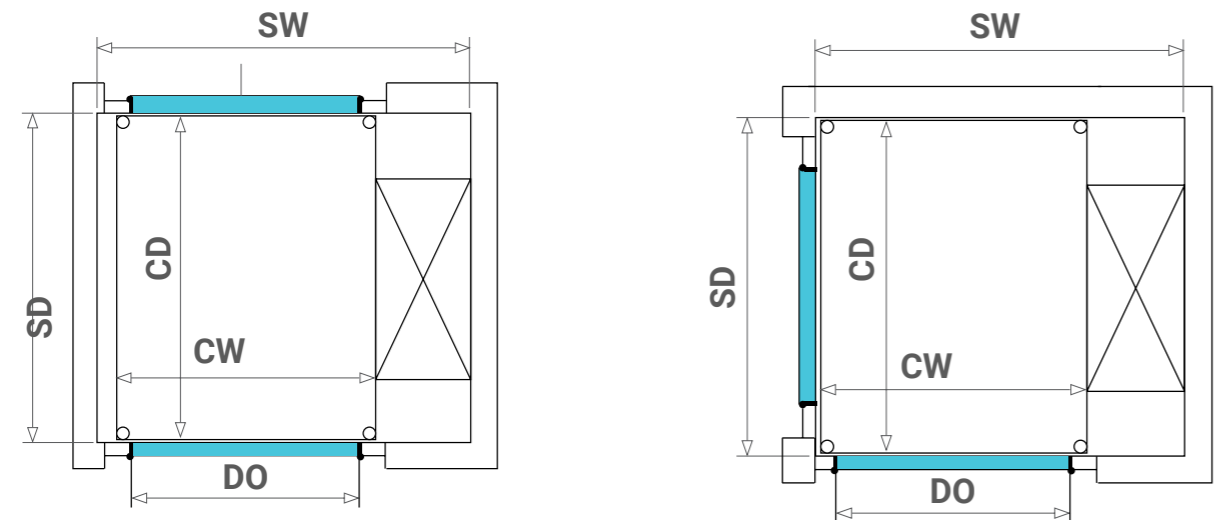

Sliding Door

The Eltec HLB with a sliding door configuration can be customised to a variety of sizes. Next Level Elevators will work with you and provide specific plans per project.

Single Entry Configurations

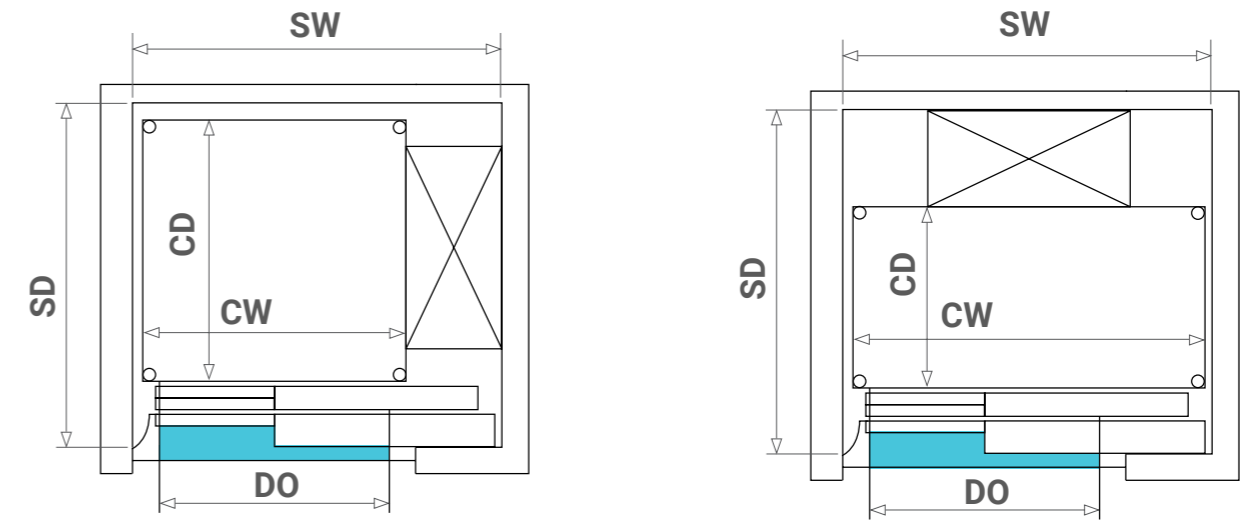

Dual Entry Configurations

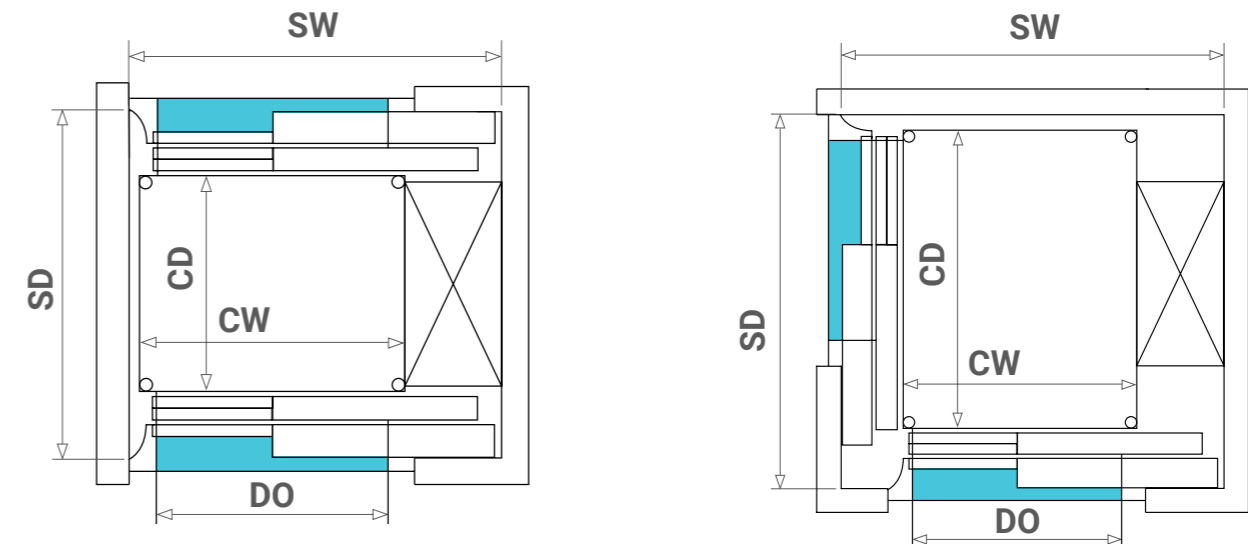



P R E M I U M

— SERVICE —

Melbourne Showroom

456 Smith Street
Collingwood VIC 3066

Sydney Showroom

19/19 McCauley Street
Matrville NSW 2036

Queensland

PO Box 6357
Meridan Plains QLD 4551